

TOTO®

MW6043046CUFG(A)

UltraMax® II 1G® / WASHLET®+ S500e One-Piece Toilet - 1.0 GPF

FEATURES

- Concealed supply connection for seamless installation
- Ultra high-efficiency TORNADO FLUSH® (1.0GPF/3.8LPF)
- CEFIONTECT® glaze prevents debris from sticking to ceramic surfaces for easy cleaning
- Universal Height
- Decorative one-piece design with elongated bowl
- Chrome trip lever
- 12" Rough-in, supply line sold separately
- See Spec sheet SW3046AT40 for WASHLET features

MODELS & COMPONENTS

- **MW6043046CUFGA#01**
With CEFIONTECT ceramic glaze, WASHLET+ S500e and Auto Flush
 - **CST604CUFGAT40**
Elongated bowl with CEFIONTECT
 - **SW3046AT40**
WASHLET+ S500e
 - **THU766**
Auto Flush Kit
- **MW6043046CUFG#01**
Same as **MW6043046CUFGA** without Auto Flush
 - **CST604CUFGAT40**
Elongated bowl with CEFIONTECT
 - **SW3046AT40**
WASHLET+ S500e

COLORS/FINISHES

- Standard
#01 Cotton

PRODUCT SPECIFICATION

The one-piece ultra high-efficiency TORNADO FLUSH toilet shall be 1.0GPF/3.8LPF. Universal Height Toilet with CEFIONTECT glaze finish. Toilet shall have high-profile tank, elongated front bowl and chrome trip lever. Toilet shall be **TOTO Model MW6043046CUFG__#01**.

See TOTO Specification sheet **SW3046AT40** for details on required WASHLET.



CODES/STANDARDS

- Meets and exceeds ASME A112.19.2/CSA B45.1
- Certifications: IAPMO(cUPC), EPA WaterSense, State of Massachusetts, City of Los Angeles, and others
- Code compliance: UPC, IPC, NSPC, NPC Canada, and others
- Legislative Compliance: California AB715, California Green Building Code, City of Los Angeles Water Efficiency Ordinance
- ADA compliant (when installed with trip lever located on the approach side)
- Complies with CA Prop 65 warning requirements



MW6043046CUFG(A)

UltraMax® II 1G® / WASHLET®+ S500e One-Piece Toilet - 1.0 GPF

SPECIFICATIONS

- Water Use 1.0 GPF/3.8LPF
- Flush System TORNADO FLUSH®
- Min. Water Pressure 8 psi (static)
- Water Surface 6-3/4" x 8-5/8"
- Trap Diameter 2-1/8"
- Rough-in 12"
- Trap Seal 2-1/8"
- Warranty One Year Limited Warranty
- Material Vitreous china
- Shipping Weight CST604CUFGAT40 99lbs.
SW3046AT40 15.6lbs.
- Shipping Dimensions CST604CUFGAT40
32"L x 20"W x
17-3/4"H¹ x 28-3/4"H²
SW3046AT40
23-3/4"L X 17"W X 9-1/2"H
- See Spec sheet **SW3046AT40** for WASHLET details

INSTALLATION NOTES

Back-to-Back Toilet Installations:

TOTO recommends the use of a nationally listed, double sanitary tee-wye only, in vertical waste stacks, in accordance with the stipulations noted in the majority of nationally recognized plumbing codes.

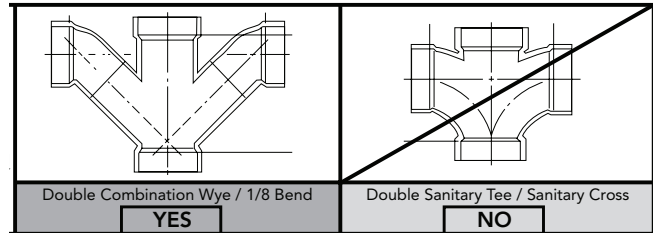

Install this product according to the installation guide.

Will comply with ADA when installed per Section 604 Water Closets and Toilet Compartments of the ADA 2010 Accessible Design Standard with seat height between 17" to 19", trip lever on approach side and flush actuation force of less than 5lbs.

Will comply with CSA B651 when installed per Clause 6.2.6 Toilets of the CSA 2012 Accessible Design Standard with seat height between 17" to 19", trip lever on approach side and flush actuation force of less than 5lbs.

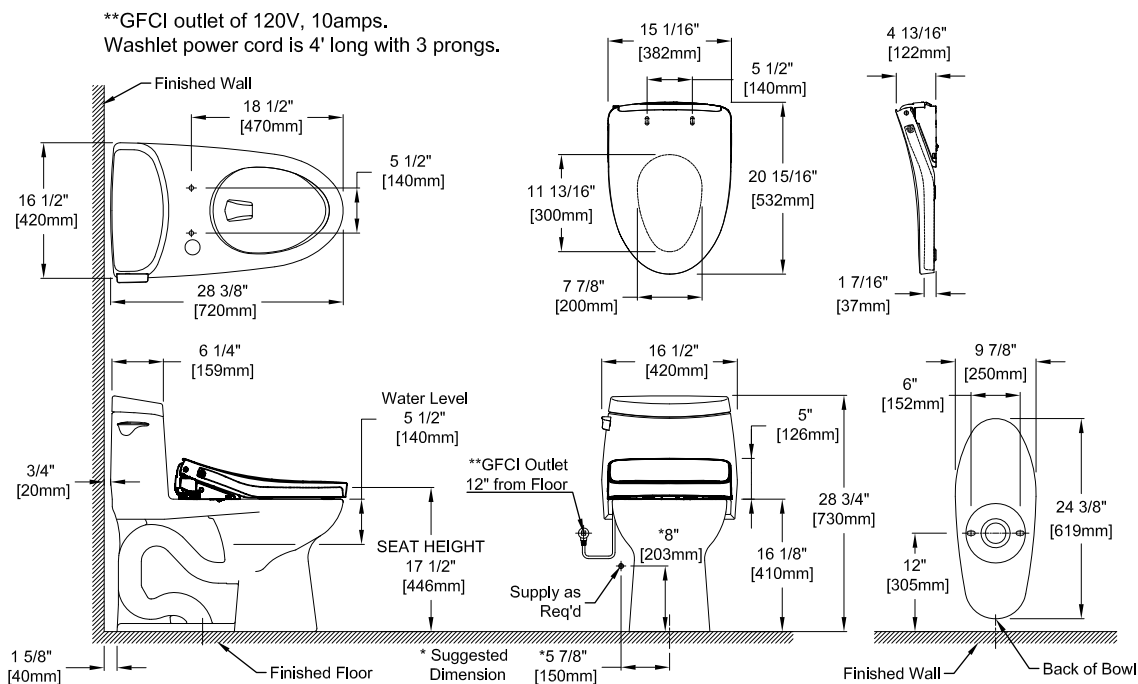

TOTO

These dimensions and specifications are subject to change without notice